

IVR-5XXXX

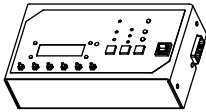

Components

① CN-100



② Power cable



③ Cable assy.

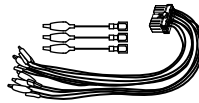

④ This Manual

Features

- Line Voltage Requirements : 100~240VAC / 50Hz-60Hz
- This checker can inspect New-Era regulators (IVR for 12V & 24V).
- This checker has the function to protect over current.

The meaning for Display

- ① OVER CURRENT : To figure out current surge
- ② SHORT CIRCUIT : In case of short circuit during inspecting on STEP1 or STEP 2, short circuit is happened inside of IVR Circuit
- ③ SHORT CIRCUIT ST : In case of short circuit before inspecting on STEP 1 or STEP 2, short circuit is happened by wrong wiring

※When new item regulators will be added on current regulator list, you could get new data by downloading from HP as below.

"<http://www.newera.co.jp/product/ivrchecker/cn100.html>"

※The contents in our instruction manual would be changed without prior announcement.

Connection / Setting

1. Connect **Cable assy.** and **Power cable** to CN-100
2. Turn **Power switch** on
3. Connect **IVR** to **CN-100**
4. Select **>LA** or **LB**
 - >**S&Dummy** or **C off** or **C on**
 - >**Choke Drive** or **No Choke Drive**
 - >**T off** or **T on**
 - >**R1** or **Off** or **Step1 Skip**
 - >**R2** or **Off** or **B-T Short**

Operation

- ① Select **12V** or **24V**
- ② Press **Step** :STEP1
Step :STEP2
- ③ End of check , Press **Reset**
- ④ Connect next IVR
- ⑤ Same model :return ②
Other model :return 3.

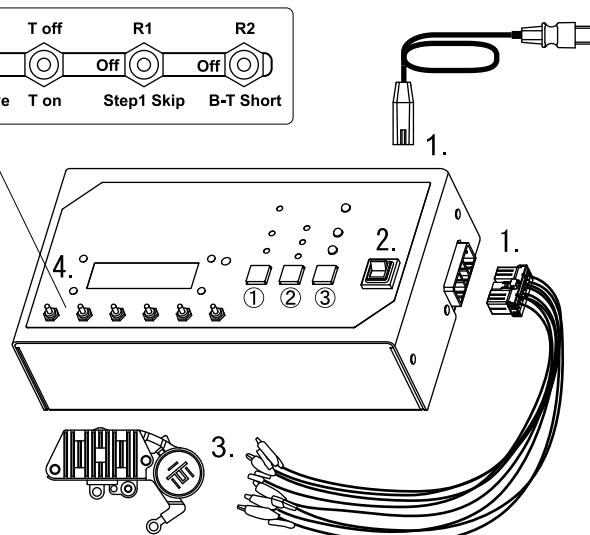
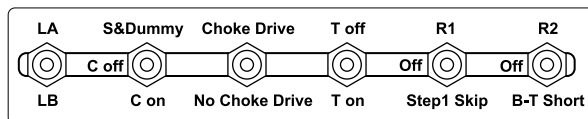

IVR-5000

LA	S&Dummy	Choke Drive	T off	R1	R2
	C off			Off	Off
LB	C on	No Choke Drive	T on	Step1 Skip	B-T Short

STEP1 : Charge Lamp
 STEP2 : Choke Drive
 Regulated voltage **28.0V~29.1V**■

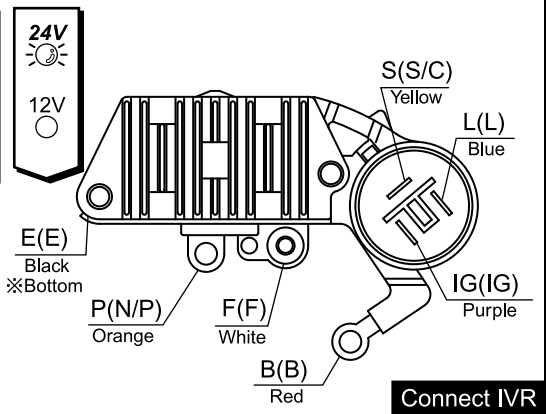

Connect IVR

IVR-5001

LA	S&Dummy	Choke Drive	T off	R1	R2
	C off			Off	Off
LB	C on	No Choke Drive	T on	Step1 Skip	B-T Short

STEP1 : Charge Lamp
 STEP2 : Choke Drive
 Regulated voltage **14.0V~15.1V**■

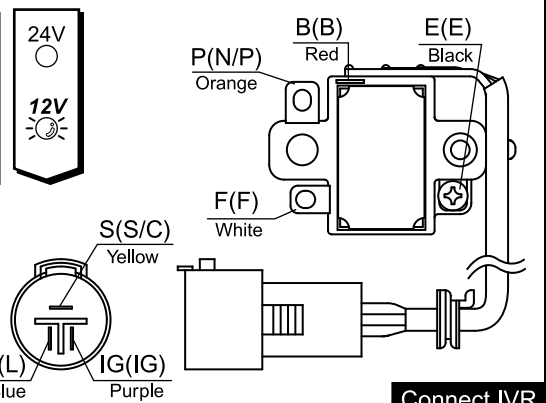

Connect IVR

IVR-5002

LA	S&Dummy	Choke Drive	T off	R1	R2
	C off			Off	Off
LB	C on	No Choke Drive	T on	Step1 Skip	B-T Short

STEP1 : Charge Lamp
 STEP2 : Choke Drive
 Regulated voltage **14.0V~15.1V**■

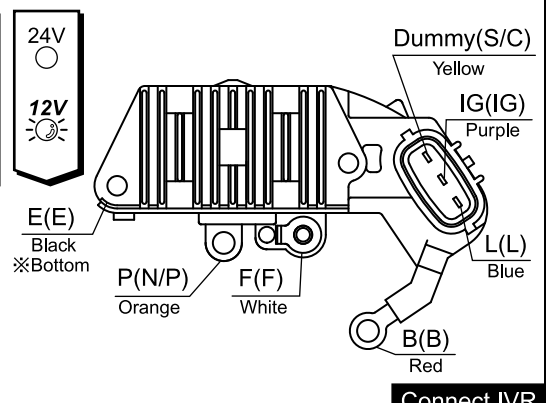

Connect IVR

IVR-5003

LA	S&Dummy	Choke Drive	T off	R1	R2
	C off			Off	Off
LB	C on	No Choke Drive	T on	Step1 Skip	B-T Short

STEP1 : Charge Lamp
 STEP2 : Choke Drive
 Regulated voltage **14.0V~15.1V**■

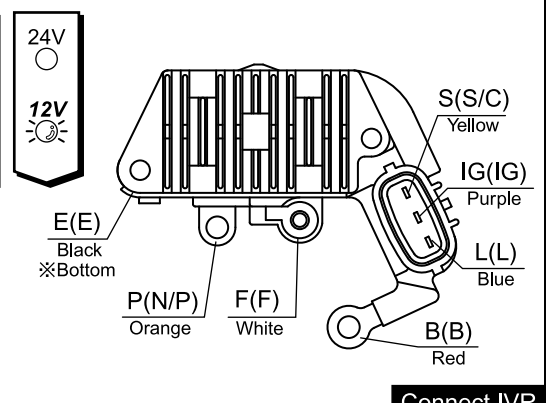

Connect IVR

LA	S&Dummy	Choke Drive	T off	R1	R2
	C off			Off	Off
LB	C on	No Choke Drive	T on	Step1 Skip	B-T Short

STEP1 : Charge Lamp

STEP2 : Choke Drive

Regulated voltage **14.0V~15.1V**■

Connect IVR

IVR-5004

LA	S&Dummy	Choke Drive	T off	R1	R2
	C off			Off	Off
LB	C on	No Choke Drive	T on	Step1 Skip	B-T Short

STEP1 : Charge Lamp

STEP2 : Choke Drive

Regulated voltage **14.0V~15.1V**■

Connect IVR

IVR-5005

LA	S&Dummy	Choke Drive	T off	R1	R2
	C off			Off	Off
LB	C on	No Choke Drive	T on	Step1 Skip	B-T Short

STEP1 : Charge Lamp

STEP2 : Choke Drive

Regulated voltage **14.0V~15.1V**■

Connect IVR

IVR-5006

LA	S&Dummy	Choke Drive	T off	R1	R2
	C off			Off	Off
LB	C on	No Choke Drive	T on	Step1 Skip	B-T Short

STEP1 : Charge Lamp

STEP2 : Choke Drive

Regulated voltage **14.0V~15.1V**■

Connect IVR

IVR-5007

IVR-5008

LA	S&Dummy	Choke Drive	T off	R1	R2
	C off			Off	Off
LB	C on	No Choke Drive	T on	Step1 Skip	B-T Short

STEP1 : Charge Lamp
 STEP2 : Choke Drive
 Regulated voltage **14.0V~15.1V**■

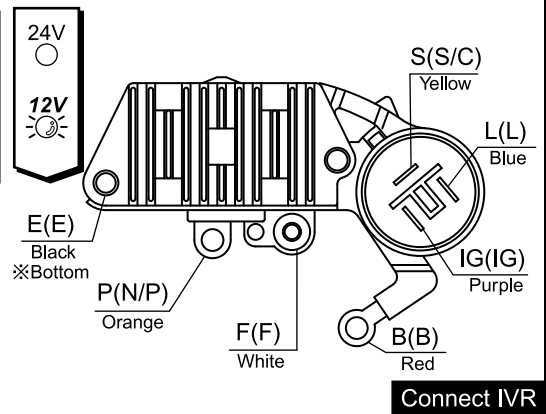

IVR-5009

LA	S&Dummy	Choke Drive	T off	R1	R2
	C off			Off	Off
LB	C on	No Choke Drive	T on	Step1 Skip	B-T Short

STEP1 : Charge Lamp
 STEP2 : Choke Drive
 Regulated voltage **14.0V~15.1V**■

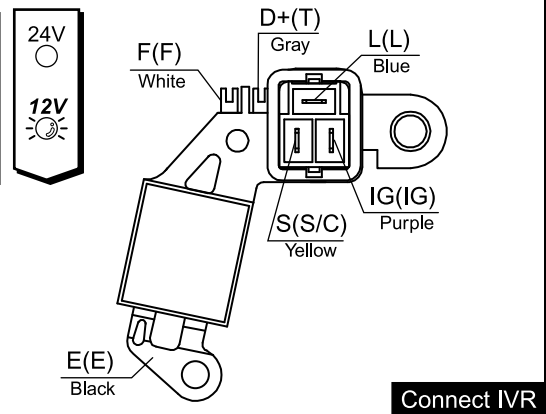

IVR-5010

LA	S&Dummy	Choke Drive	T off	R1	R2
	C off			Off	Off
LB	C on	No Choke Drive	T on	Step1 Skip	B-T Short

STEP1 : Charge Lamp
 STEP2 : Choke Drive
 Regulated voltage **14.0V~15.1V**■

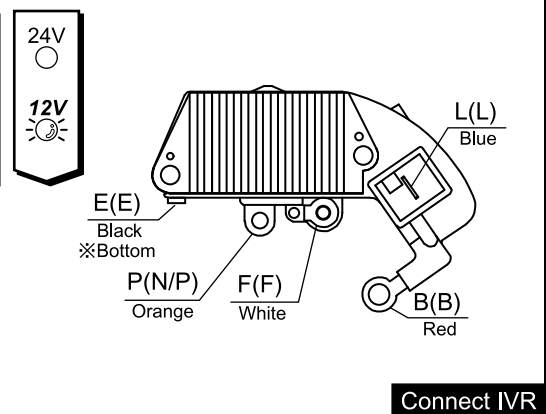

IVR-5011

LA	S&Dummy	Choke Drive	T off	R1	R2
	C off			Off	Off
LB	C on	No Choke Drive	T on	Step1 Skip	B-T Short

STEP1 : Charge Lamp
 STEP2 : Choke Drive
 Regulated voltage **14.0V~15.1V**■

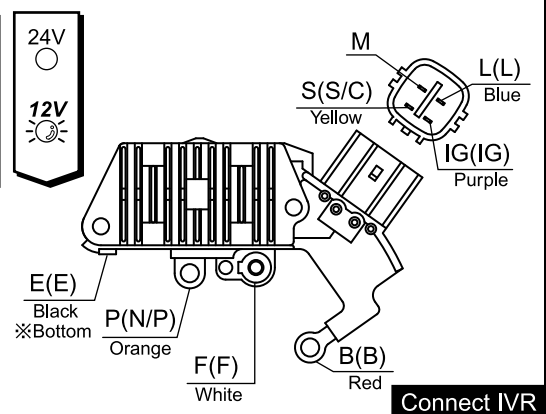

LA	S&Dummy	Choke Drive	T off	R1	R2
	C off			Off	Off
LB	C on	No Choke Drive	T on	Step1 Skip	B-T Short

STEP1 : Charge Lamp

STEP2 : Choke Drive

Regulated voltage **14.0V ~ 15.1V**

24V

12V

Connect IVR

IVR-5012

LA	S&Dummy	Choke Drive	T off	R1	R2
	C off			Off	Off
LB	C on	No Choke Drive	T on	Step1 Skip	B-T Short

STEP1 : Charge Lamp

STEP2 : Choke Drive

Regulated voltage **14.0V ~ 15.1V**

24V

12V

Connect IVR

IVR-5013

LA	S&Dummy	Choke Drive	T off	R1	R2
	C off			Off	Off
LB	C on	No Choke Drive	T on	Step1 Skip	B-T Short

STEP1 : Charge Lamp

STEP2 : Choke Drive

Regulated voltage **14.0V ~ 15.1V**

24V

12V

Connect IVR

IVR-5014

LA	S&Dummy	Choke Drive	T off	R1	R2
	C off			Off	Off
LB	C on	No Choke Drive	T on	Step1 Skip	B-T Short

STEP1 : Charge Lamp

STEP2 : Choke Drive

Regulated voltage **14.0V ~ 15.1V**

24V

12V

Connect IVR

IVR-5015